

freeway

Flow Shower Cradle



User Manual

1	Introduction	3
1.1	Manufacture	3
1.2	Symbols Used	4
1.3	Contraindications / Limitations	5
1.4	Intended Use	5
1.5	Safety Instructions and Warnings	6
2	Components/Key Parts	7
2.1	Cradle Configurations	8
3	Accessory List	8
4	Assembly Instructions	9
4.1	Attaching & Detaching the Shower Cradle Mesh	9
4.2	Attaching Head Cushion	10
4.3	Attached Waist Strap	11
5	Operating Instructions	11
5.1	Manually Adjusting the Product Height	11
5.2	Operating the Braked Castors	12
5.3	Using the Commode Pan (Accessory)	12
5.4	How to use and adjust the waist straps	13
5.5	Operating the Tilt Lever	13
6	Technical Specification	14
6.1	Shower cradle Frame Dimensions	14
7	Environmental Conditions	15
7.1	Operating Environment	15
7.1.1	Normal Operating Conditions	15
7.2	Storage Conditions	15
7.2.1	Shipping and Storage Conditions	15
8	Daily Checks	16
9	Cleaning	17
9.1	Metal Frame Cleaning	17
9.2	Mesh Cleaning	17
9.2.1	Washing Guidelines	17
9.2.2	Drying Guidelines	17
9.3	Disinfecting (if necessary)	18
10	Servicing	19
11	Troubleshooting	20
12	Disposal	20
13	Warranty	21
14	Service Record History	22

1 Introduction



This user manual should be kept safe for future reference.



Please read and understand this manual in its entirety before using your Freeway Shower Cradle.

The information in this manual is important for the safety of anyone near the shower cradle and must be read and understood to help prevent injuries. It is also crucial to the proper operation and maintenance of the.

Should any questions arise from reviewing this manual, contact your local authorised representative.

Failure to comply with warnings in this manual may result in; injury to the operator and/or client and/or damage to the shower cradle or related components.

If, during the use of this device or because of its use, a serious incident has occurred please report it to the manufacturer and to your national authority.

Store this manual with the documents included with the shower cradle. Contents of this manual are subject to change without prior written notice.



Do not attempt to use this equipment without first understanding the contents of this manual.



Unauthorised modifications on this product may affect its safety. The manufacturer will not be held responsible for any accident, incident or deficiencies of performance that occur because of any unauthorised modification to its products.

1.1 Manufacture

The shower cradle is manufactured at the address below:



Prism Medical UK

Unit 1, Tir Llwyd Industrial Estate, St Asaph Avenue, Kinmel Bay, Conwy, LL18 5JZ
Telephone number: 01924 840100

1.2 Symbols Used

The Table below includes all symbols from BS EN ISO 15223-1:2021 that can be found in this manual and on the Product and what they represent. Refer to this Table when you are unsure of what a symbol represents.

















			
Place of Manufacture	Country of Manufacture	Serial number	Catalogue number
			SWL
Caution – see instructions for use	Consult instructions for use	UK Conformity Assessed	Safe Working Load
			
For internal use only	Packaging indicator – Keep dry	Do not use if package is damaged	Packaging indicator – This way up
			
Fragile, handle with care	Please observe local laws on recycling	Non-sterile	Atmospheric pressure limitation
			
Temperature range	Humidity range		

Table 1-1

1.3 Contraindications / Limitations

There are no known “contraindications” associated with the usage of the shower cradle, provided it is used as per the manufacturer’s recommendations and guidelines. However, it is recommended that a client specific assessment is completed by a trained and knowledgeable health care professional to determine the method of transfer and use.

The manufacturer does not recommend a required number of operators for the use of our products. This information and recommendation can only be provided after a thorough personalised, case specific assessment, as there are many factors that can influence these decisions.

Limitations of the cradle include:

- The cradle should only be operated by individuals who are competent and have received appropriate training on its use.
- The cradle should only be used with users weighing under the safe working load of the cradle.
- The cradle is only to be used within the environment it is intended for. Cradles must only be relocated by an authorised person.
- The cradles are designed for human transfer/use only. There is no other application to this product.
- The operator of the cradle must always pay attention to the well-being of the user. Users should not be left unsupervised during operation.
- A carer must operate the cradle during use.

1.4 Intended Use



For internal use only.

The shower cradle, with a SWL (safe working load) of 130kg is designed to provide safe, and comfortable seating and showering of a user. The cradle is easily manoeuvrable with easy-to-use hygiene solution.

The shower cradle’s primary use is to provide the user with an effective solution for their showering and commode needs. It enables the transfer of the user to the showering room, allowing them to receive a shower while comfortably seated in the cradle.

The cradle is equipped with castors that feature independent locking brakes, ensuring ease of movement while prioritising user stability and safety. Additionally, the castors can also be manually height adjusted to suit carers of different heights.

The shower cradle features a specially designed mesh that attaches to the cradle using a buckle system. This mesh is removable for cleaning, washing, and drying and is expected to be replaced over the lifetime of the metalwork. Please consult the ‘assembly’ section for the proper attachment and detachment of the mesh to maintain the user’s safety.

The manufacturer always recommends training before use of our products. For more details on the training that can be provided please contact your local authorised dealer.



The device is used under instruction, and the operation of the aid is undertaken by a trained carer. A risk assessment must be performed before using the cradle to ensure safe use can be established.



You may need to seek specialist advice on how to assist some people with specific moving and handling needs. Sources of advice include, but are not limited to, professional bodies and organisations, occupational therapists, physiotherapists, manual handling advisers and ergonomists with experience in health and social care.

1.5 Safety Instructions and Warnings



Ensure to read and understand all the statements below, for the safety of the caregivers and users, along with warranty requirements.

- If you are unsure on the correct use of this product, please contact the manufacturer or a professional for further information or training.
- The person should only be moved while the cradle is in the fully tilted-up transport position.
- Do not attempt to tilt the cradle when it is unoccupied, as the gas struts are designed to operate with weight present.
- The shower cradle must only be operated (placing the user into/out of the cradle) on a levelled surface.
- The cradle should be used to transfer a person on a level surface, so do not exceed a slope of 5°.
- Exercise caution during the transfer of the person, avoid moving them too quickly, as this increases the risk of accidents.
- Shower cradles have less grip when pushed on a wet surface; be vigilant of the surroundings.
- Under no circumstance should the shower cradle be put in control of a person who has not been properly trained in the use and care of this equipment. Failure to adhere to this warning may result in serious injury to the operator and/or the user.
- The shower cradle and associated accessories are not toys. Do not use it for unsafe practices. Do not allow children to play with the shower cradle or any of its components. The shower cradle should not be used for any practice except its intended use.
- In facilities where more than one operator will be responsible for using the shower cradle, it is important that all such members be trained on the shower cradle prior to use. A training program should be established by the facility to acquaint new operators with this equipment.
- Your guarantee is void if persons unauthorised by the manufacturer perform work on the shower cradle.
- To maintain optimum function, the cradle should be inspected and maintained on a regular basis.
- The shower cradle and the associated accessories are intended only for showering and transferring of a person. The manufacturer will not be responsible for any damage caused by the misuse, neglect, or purposeful destruction of the equipment and/or its associated components.
- Any accessories used with the shower cradle should be checked before each use to ensure that they are in good working order. Check for signs of wear and ensure that all labels are legible. Report any unusual wear to your local authorised dealer.
- The shower cradle and its associated accessories are certified to a maximum load of 130kg. Do not exceed the maximum rated load of any of the components.
- Ensure that a clear space is maintained around the shower cradle. Before using the shower cradle always check for and move away any obstacles.
- Never leave a person unattended in the shower cradle.
- The shower cradle is not intended to be used as a seating product for extended periods of time.
- When the shower cradle is not in use, apply the castor brakes to prevent unwanted lateral movement.

2 Components/Key Parts

Please see below to familiarise yourself with the components of the shower cradle. If you have not received all the components listed below, contact your local dealer immediately – contact details are provided on the last page of this manual.

Item	Description
1.	Tilt In Space Lever
2.	Removable Mesh Fabric
3.	Stainless Steel Frame
4.	Height Adjustable Braked Castors
5.	Height Adjustable Clips
6.	Gas Struts
7.	User Manual

Table 2-1



Fig. 2-1

2.1 Cradle Configurations

The shower cradle is available in various configurations, including width and mesh type. See list below for the standard options.

Frame Options	
Frame Width Type	Benefits
Small	To accommodate various users' needs
Medium	To accommodate various users' needs
Large	To accommodate various users' needs

Table 2.1-1

Mesh Options	
Mesh Type	Benefits
Full Mesh	Standard seat providing maximum comfort
Aperture Mesh	Allowing access for toileting

Table 2.1-2

3 Accessory List

The list below shows a list of approved compatible accessories that can be ordered at any time during the life of the shower cradle. Contact your local dealer to order these parts.



If the side support and commode pan tray are ordered together with the cradle, they will come pre-installed. However, if these accessories are ordered separately, we recommend they are fitted to the cradle by a qualified service engineer. For further details please contact your local dealer.

Accessories		
Description	Part number	Comments
540mm Waist band VELCRO® Brand fastener	880409	For size large width frame
490mm Waist band VELCRO® Brand fastener	880412	For size medium width frame
440mm Waist band VELCRO® Brand fastener	880418	For size small width frame
540mm Waist band buckle fastening	880408	For size large width frame
490mm Waist band buckle fastening	880411	For size medium width frame
440mm Waist band buckle fastening	880417	For size small width frame
Comfort Pad for 540mm Waist Strap	880413	To fit behind 540mm buckle/VELCRO® Brand fastener waist strap to provide comfort for user
Comfort Pad for 490mm Waist Strap	880414	To fit behind 490mm buckle/VELCRO® Brand fastener waist strap to provide comfort for user
Comfort Pad for 440mm Waist Strap	880415	To fit behind 440mm buckle/VELCRO® Brand fastener waist strap to provide comfort for user

Flow Head Support Cushion	155805	Suitable for all different width frames
Commode Tray & Pan Kit (for small or medium Cradle)	155800	Kit to fit and used on the small or medium width cradle.
Commode Tray & Pan Kit (for large Cradle)	155801	Kit to fit and used on the large width cradle.
Upper Side Rail Kit (Small) (Pair)	155802	Complete Rail kit including padding to fit to small width cradle
Upper Side Rail Kit (Medium/Large) (Pair)	155803	Complete Rail kit including padding to fit to medium/large width cradle
Lower Side Rail Kit (Small/Medium/Large) (Pair)	155804	Complete Rail kit including padding to fit to small/medium/large width cradle

4 Assembly Instructions

The sections below will give detailed instructions on how to install and remove the accessories from your chair. These instructions must be adhered to for a successful and safe assembly of the chair. If you are unsure of any processes, always seek advice.

4.1 Attaching & Detaching the Shower Cradle Mesh



The mesh must be fitted correctly to ensure the safe and prolonged use of this product.

- To attach the mesh fabric, start at the bottom of the frame and slide the pocket over the metalwork, ensuring that the label is visible and facing forward towards the castors, as shown in Fig.4.1-1.
- Continue working up the metalwork connecting one buckles at a time, as shown below in Fig.4.1-2.
- Once you reach the top connect the three 25mm buckles and pull the belts to tighten the mesh, as shown in Fig.4.1.3
- After connecting and tightening all the buckles at each section, make sure to thread the remaining part of the belt through the loop to prevent it from hanging down, as shown below in Fig 4.1.4



Fig. 4.1.1



Fig. 4.1.2



Fig. 4.1.3



Fig. 4.1-4

If you have purchased a Cradle with a mesh aperture, this fits to the chair in the same way as instructed above, with addition of the hook and loop section, which attached to the frame, as shown below on Fig.4.1-5, Fig. 4.1-6, and Fig. 4.1-7.



Fig. 4.1.5



Fig. 4.1.6



Fig. 4.1.7

4.2 Attaching Head Cushion

- a. Remove the cushion from the packaging.
- b. Unfasten the clips on the straps located on the rear of the padding.
- c. Place the padding to the head section of the cradle, as shown in Fig. 4.2-1.
- d. Secure in place by re-attaching the clips around the back of the of the cradle, as shown below in Fig. 4.2-2.



Fig. 4.2-1

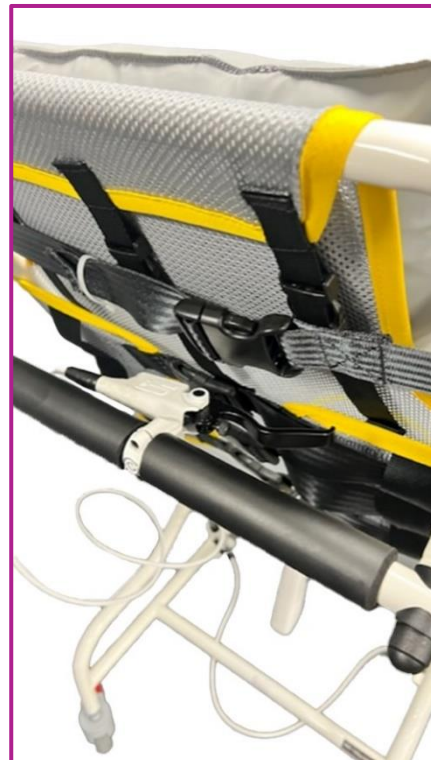

Fig. 4.2-2

4.3 Attached Waist Strap

- Remove the strap from the packaging.
- You'll find a short strap loop in the middle of the strap. Unfasten the square hook and loop patch on one side and pass the longer strap around the cradle back, as shown in Fig. 4.3-1 and Fig 4.3-2.
- Secure it in place by re-attaching the hook and loop patch to create a retaining loop, as shown below in Fig. 4.3-3
- This allows the strap to remain in place when not in use.



Fig. 4.3-1



Fig. 4.3-2



Fig. 4.3-3

5 Operating Instructions



This product may be heavy for users and must be lifted with care. Please operate this product with the use of the castors wherever possible to prevent any injury.

Appropriate training in lifting, handling, and bathing procedures should be undertaken by any person operating this product, along with any other additional aid equipment, for their own and the client's safety and comfort. These instructions are designed to cover the method of using the product.

5.1 Manually Adjusting the Product Height



Never attempt to adjust the height of the product when someone is sitting in the shower cradle. All four castors must be set to the same height before use. Make sure that the plastic retaining clip is fully inserted, the pin must pass through the tube.

- Adjust one castor at a time, by remove the plastic retaining clip, as shown below in Fig. 5.1-1.
- Slide the castor bar up or down to the desired height setting ensuring the hole on the tube lines up with the hole on the castor bar, as shown below in Fig. 5.1-2.
- Place the plastic retaining clip back in the hole ensuring that it fully goes through the tube, as shown in Fig.5.1-3.
- Repeat this process for the remaining castors.



Fig. 5.1-1

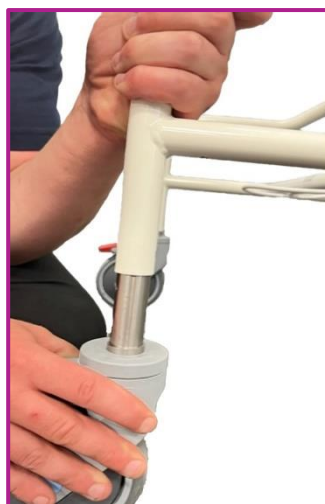

Fig. 5.1-2



Fig. 5.1-3

5.2 Operating the Braked Castors

The castors on the shower cradle are individually braked using your foot.



Make sure appropriate footwear is worn when using this product. Do not try to push the product when the castor brakes are activated.

To activate the brake, place your foot on the red section of the castor and push down, as shown below in Fig 5.2-1. The red plastic will stay in the down position, indicating the brake is engaged, as shown below in Fig. 5.2-2. Repeat the process for all castors to ensure that the product is securely in position. To release the brakes, simply push down the red plastic part of the brake, as shown below in Fig. 5.2-3.



Fig. 5.2-1



Fig. 5.2-2



Fig. 5.2-3

5.3 Using the Commode Pan (Accessory)



Make sure that the commode pan is empty before transferring the shower cradle. The commode pan has a maximum capacity of 6 litres.

The plastic commode pan is designed to self-locate onto the pan tray located underneath the seat. This can be done by sliding the pan in and out from rear of the shower cradle, aligning it with the tray, as shown below in Figures Fig. 5.3-1, Fig. 5.3-2, and Fig. 5.3-3. Before inserting, remember to remove the lid and store in a suitable location.



Fig. 5.3-1



Fig. 5.3-2



Fig. 5.3-3

5.4 How to use and adjust the waist straps

- Once the straps have been attached to the frame, please consult section 4 assembly instructions.
- Gently loosen the adjustment straps to enable the buckles to come together while the user is seated in the chair, as shown below in Fig. 5.4-1.
- After making the required adjustments, firmly secure by fastening the buckles together, as shown below in Fig. 5.4-2.
- Tighten the adjustment strap to achieve a comfortable fit for the user.

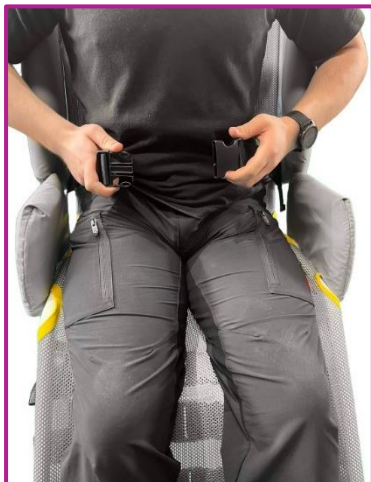

Fig. 5.4-1



Fig. 5.4-2

5.5 Operating the Tilt Lever



Operation of the tilt lever should only be done when someone is present in the shower cradle. When empty the shower cradle should also be in the fully tilted forward position.

- Locate the Tilt Lever on the push handlebar on the rear of the cradle, as shown below in Fig. 5.5-1
- To tilt the cradle, place both hands on the rubber pram handle and squeeze the lever, as shown below in Fig. 5.5-2.
- While maintaining pressure on the lever, either push down or pull up on the handlebar to achieve the desired tilt for the cradle. Once you've reached the right position for the user, release the tilt lever and the cradle will securely hold its position, as shown below in Fig. 5.5-3.



Fig. 5.5-1



Fig. 5.5-2



Fig. 5.5-3

6 Technical Specification

6.1 Shower cradle Frame Dimensions

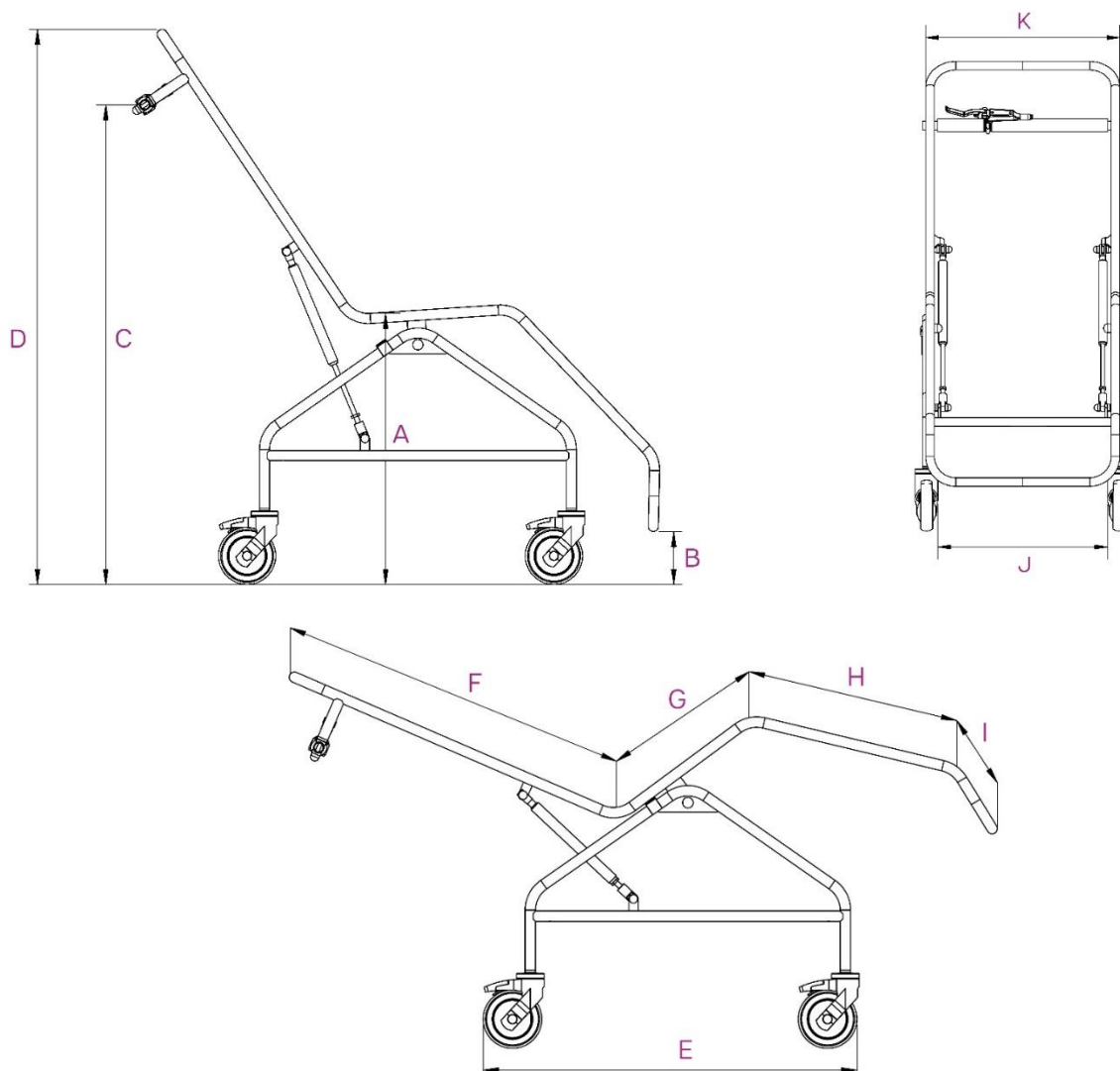

Cradle Dimensions– millimetre			
Dimensions (Ref to drawing)	Small	Medium	Large
A – Seat Height	592	592	592
B – Cradle End Height	176	116	112
C – Handle Height	940	1050	1066
D – Overall Height	1106	1214	1256
E – Base Frame Length	800	800	800
F – Back Length	620	750	800
G – Seat Length	300	350	400
H – Leg Length	360	450	460
I – End Length	150	150	150
J – Internal Width	440	440	440
K– Overall Width	502	502	582
Upright Length	950	1134	1134
Reclined Length	1260	1508	1508
Turning Circle	836	836	886
Castor Size	125	125	125
Footrest Adjustment	155	155	155

Flow Cradle Weight Specifications			
	Small	Medium	Large
Safe Working Load (SWL)	130kg	130kg	130kg
Commode SWL (Capacity)	6L	6L	6L
Product & Packaging Weight	16kg	16kg	16kg
Product Weight	15kg	15kg	1kg

Table 5.1-1

7 Environmental Conditions

The sections below will give detailed information regarding the environmental conditions the product should maintain throughout its life cycle. Failure to adhere to these conditions may negatively impact the function of the product. If you are unsure of any environmental conditions, always seek advice.

7.1 Operating Environment

The shower cradle is intended to be used in both dry and wet environments, with its primary use being in shower rooms. The shower cradle is intended for internal use only.

The shower cradle is intended to be used within a professional healthcare facility or home healthcare environment. The shower cradle is not suitable for any other environment.

The shower cradle is not intended to be used in environments where there are rapid changes in the environmental temperature and humidity.

7.1.1 Normal Operating Conditions

+5°C to +40°C (41°F to 104°F) at a relative humidity between 15% to 90% RH, non-condensing but not requiring a water vapour pressure greater than 50hPa and atmospheric pressure between 700hPa to 1060hPa.

7.2 Storage Conditions

The shower cradle is intended for internal storage within normal environmental conditions. The shower cradle is intended to be stored in a dry room.

It is not intended to be stored in environments where there are rapid changes in the environmental temperature.

When storing the cradle, ensure that the product has been cleaned and dried. For further information, refer to the 'cleaning' section instructions.

7.2.1 Shipping and Storage Conditions

-25°C to +5°C (-13°F to 41°F) with any humidity level.

+5°C to +35°C (41°F to 95°F) at a relative humidity up to 90%.

+35°C to 70°C non-condensing at a water vapour pressure up to 50hPa.

8 Daily Checks

Inspection is to be completed prior to each use by the user of the shower cradle.



Should any of the components in the table below fail the inspection, DO NOT use the shower cradle. Contact your local authorised dealer for service – contact details are on the last page of this manual.

Ensure all component inspections in the table below are completed prior to each use of the shower cradle.

Check list before use:

Component	Service/inspection required
Generic	Visual inspection of the external of the shower cradle. Significant damage that may affect the shower cradle's function and a clear safety hazard is unacceptable.
	Check the product labelling to ensure they are all still legible. This includes the serial number and other important markings. If labels are not legible, then contact your local authorised dealer immediately.
	Check all main nuts and bolts to see if they are loose. If they are not tight or you have concerns, then contact your local authorised dealer immediately.
Mesh	Inspect the mesh for any damage including tears and excessive wear. If the integrity of the mesh is compromised, it should be replaced.
	Ensure that the mesh is fixed onto the frame correctly. See section 4 assembly instructions for guidance.
Brakes	Ensure the brakes function when activated.
	Ensure the product can move freely when the brakes are deactivated. (Ensure they aren't rubbing on the wheels).
Castors	Examine the products' castors for signs of damage or wear, ensuring they run freely and are not cracked.
	Check the castor fixings for hair and dirt etc., as a build-up can restrict the castor movement.
	Check to see all castors are flat on the floor and shower cradle is stable.
	Ensure the product can rotate freely with ease.

Table 8-1

9 Cleaning



To reduce the risk of cross-contamination it is recommended to clean the shower cradle and accessories before use by a different person.

Please follow the recommended cleaning guidelines below on cleaning and disinfecting the shower cradle.

9.1 Metal Frame Cleaning

The metal frames of the chairs are powder-coated with a coating containing a silver anti-microbial additive. The coating provides increased scuff and abrasion resistance compared to conventional paint, which will help protect the product from rust etc., while reducing the levels of MRSA bacteria by at least 99.99%.

For mild cleaning the frames can be cleaned using a damp cloth, soap/water, and antibacterial spray. For a deeper clean, a low-pressure steam cleaner can also be used. Do not use a steam cleaner at high pressure, as this could damage the powder coating and labels. Do not use industrial bleaches, abrasive cleaners, or organic solvents.

All cleaning solutions must be thoroughly rinsed off the product at the end of the cleaning process and the product dried using a dry cloth/towel. Always ensure the product is dry before use.

9.2 Mesh Cleaning

The mesh fabric is treated with a special Polygiene antimicrobial coating, which is an agent that kills microorganisms or stops their growth, leaving the fabric fresh and odour free.

The material can be wiped down using a damp cloth to remove any mild dirt, dust, and minor spillages. When a spillage occurs, it is recommended that it be cleaned as quickly as possible to avoid any staining; it is good practice to dab the spillage and not to rub it as this could cause staining.

9.2.1 Washing Guidelines

- a. Follow the washing recommendation specified on the label attached to the mesh fabric, with maximum temperature of 80 degree.
- b. Prior to washing, make sure all buckles and hook and loop fixing are fully closed.
- c. We recommended non-biological washing detergents and do not use fabric softeners and conditioners.
- d. To prevent fabric deterioration and potential skin irritation, always ensure a thorough rinse during the washing process.

9.2.2 Drying Guidelines

- a. Follow the drying recommendation specified on the label attached to the mesh fabric.
- b. We recommended Air Drying the mesh fabric.
- c. If using a tumble dryer, select a low heat setting with a short cycle.
- d. Do not place the product on, heaters, steam pipes or radiators to prevent overheating, which could compromise the material components and the integrity of the mesh fabric.

9.3 Disinfecting (if necessary)

Should the shower cradle require a more thorough cleaning, the use of the Actichlor™ disinfectant product (which is widely available in tablet form and used throughout the healthcare industry) is recommended.



Follow the manufacturer's safety instructions for the use of this cleaning product before use to ensure safe use for the operator and the user.

Ensure the cloth is damp before the cleaning process.

Application is through a clean damp cloth applied to wipe the product down. Use in the following dilutions to ensure an effective clean:

- Actichlor™ dissolvable chlorine tablets provide a concentration of 1000 ppm of available chlorine (0.1%) per 1 tablet.
- 1 tablet (1.7g formed tablet (x1)) will create a virucidal solution, diluted in 1 litre of water to provide effective means to clean a "dirty" product. This is also ideal for use after an outbreak of the Norovirus/winter vomiting and can be used as a precaution against C.Diff. It is effective against viruses, bacteria, spores, yeasts, and moulds.
- A minimum of 5 minutes contact time with the outer components is recommended to prevent virucidal infections, whilst maintaining the integrity of the product. The product can withstand a longer contact period, however a minimum of 5 minutes is required to provide an effective cleaning regime.
- Blood spills should be dealt with by an increased concentration of the solution – please refer to the instructions on the manufacturer's product labelling.

Dilution chart					
Product used as	Product condition	Concentration (ppm)	Dilution qty* (l)	Tablets per 1l (0.26gal)	Contact time (minutes)
Bactericidal	Clean	200	5 (1.32gal)	1	1
	Dirty	1000	1 (0.26gal)	1	5
Yeasticidal	Clean	200	5 (1.32gal)	1	1
	Dirty	1000	1 (0.26gal)	1	5
Fungicidal	Clean	2000	1 (0.26gal)	2	15
	Dirty	5000	1 (0.26gal)	5	15
Mycrobactericidal	Clean	1000	1 (0.26gal)	1	15
	Dirty	5000	1 (0.26gal)	5	15
Virucidal	Clean	500	2 (0.53gal)	1	5
	Dirty	1000	1 (0.26gal)	1	5
Sporcidal (C. Diff)	Clean	1000	1 (0.26gal)	1	10
	-	-	-	-	-
Sporcidal	Clean	5000	1 (0.26gal)	5	10
	-	-	-	-	-

- Dilution is made with water. DO NOT dilute within any other medium.
- When diluted in water, one tablet gives 1000ppm of available chlorine.
- The concentration of the solution depends upon whether the object being cleaned is noticeably dirty (indicated in the table by "Product condition").

Table 9.3-1

Handling and storage safety precautions when using this cleaning agent:		
Advice on Safe Handling	Hygiene Measures	Conditions for Safe Storage
<p>Avoid contact with skin and eyes.</p> <p>Do not breathe dust, fumes, gas, mist, vapours, spray.</p> <p>Use only with adequate ventilation.</p> <p>Wash hands thoroughly after handling.</p> <p>Mixing this product with acid or ammonia releases chlorine gas.</p>	<p>Handle in accordance with good industrial hygiene and safety practice.</p> <p>Remove and wash contaminated clothing before re-use.</p> <p>Wash face, hands, and any exposed skin thoroughly after handling.</p>	<p>Keep out of reach of children.</p> <p>Keep container tightly closed.</p> <p>Store in suitable labelled containers.</p> <p>Storage temperature: 0-25°C (32-77°F).</p>
Individual Protective Measures		Dissolve
Hand protection: Gloves		Dissolve in cold water – With no agitation, 1 tablet will take approximately 10 minutes to fully dissolve in the water used.
<p>The information above has been extracted from the Actichlor™ MSDS (Manufacturers Safety Data Sheet). For a full review of the data please follow the link below: http://www.nhsggc.org.uk/media/236215/msds-actichlor-plus.pdf</p>		

Table 9.3-2

10 Servicing

Regular servicing on the shower cradle will help prevent breakdowns and reduce repair costs. It will also improve the quality of the product for the end users.

To reduce the risk of injury, no service is to be carried out on the shower cradle while in use. Service must be completed by an authorised service engineer only. Do not attempt to service the product yourself; this will void your warranty.

To ensure the safety and continued good function of your shower cradle, it is recommended to have an approved service engineer perform a routine service every 12 months, this will ensure that the product meets the required standards. It is important to document the service history of the product in the service log located at the back of this user manual after each service.

When the product is serviced, the service checklist must be completed.
Service Manual Document Number: 995147.

For information regarding spare parts, refer to the spare parts manual.
Spare Parts Manual Document Number: 992147.

Contact your local authorised dealer if you:

- Need more information.
- Have any questions about the use or service of your shower cradle.
- Notice any change in the performance.
- Want to report an unexpected occurrence.
- Want to arrange a service.
- Need to ascertain necessary information for replacement parts and components.

The expected product lifetime is **7 years**. This is dependent on usage and compliance with maintenance. Regular service on the product will increase the expected lifetime.

11 Troubleshooting

Should a problem arise with the use of the shower cradle, review the Table below.

Find the fault and complete the recommended solution.

If the fault is not listed below or the solution does not correct the problem, contact your local authorised dealer immediately – contact details are provided on the last page of this manual.

Fault	Action
Castors do not operate	Ensure the brake has been fully disengaged. Check that the castors are running freely and are level. Check the castors are not fouled with debris that would restrict their movement (clean out, test, and return to service). If this does not correct the fault, then contact your local authorised dealer immediately so the product can be checked to ensure proper continued operation.
Brakes do not operate	Ensure that the brake mechanism is fully engaged. Check to see that all castors are touching the ground. If this does not correct the fault, then contact your local authorised dealer immediately so the product can be checked to ensure proper continued operation.
If tilt operation is not holding its position	If the tilt adjustment does not operate, check the lever handle is in the released position; it may be that the lever or gas strut will require changing. If so, contact your local authorised dealer immediately so the product can be checked to ensure proper continued operation.

Table 11-1

12 Disposal

With efforts to improve the environment and reduce waste, where possible our products have been manufactured with recyclable materials. Below are our guidelines on recyclable materials and being environmentally friendly.

Please observe the local laws on recycling and respect the current laws for disposal within the community the product is being used within. If there is any uncertainty of the below guidelines, contact your local authorities to determine the proper method of disposal of potentially biohazardous parts and accessories.

Fully Recyclables	Consideration when Recycling
All steel framework	Mesh
Castors	Rubber handlebar covers
Initial packaging of the product (cardboard)	Plastic fixings
Metallic fixings – screws etc.	Harnesses + Belts

Table 12-1

When the shower cradle has completed its life cycle and can no longer perform to its intended use safely, the product should be decommissioned by an approved Service Engineer.



The product may be contaminated and must be disinfected before recycling or disposal. See section on 'Cleaning' for details of how to do this

13 Warranty

It is impossible for all the risks to be eliminated from use of this product, but to reduce risk and improve safe and proper use, the user should always read and understand the user manual before use. Product failure may occur due to lack of maintenance and care, misuse, unauthorised and improper servicing or alterations, improper storage, and environmental use, or through normal use wear and tear. These factors are all beyond the control from the manufacturer. These risks are taken on by the users.

Once registered, the manufacturer will provide a 5-year warranty period for the steelwork and 1-year warranty for all other products against all manufactured defects to the registered customer. The warranty is valid if the product has maintained its intended use and the user manual instructions have been followed. The warranty will not extend to the use of the product when used contrary to the user manual. This guarantee does not affect or in any way limit your statutory rights.

1. The liability of the manufacturer under the terms of this guarantee shall be limited to the replacement of the defective part(s) to the sales distributor, dealer, agent, person, or entity which purchased the equipment from the manufacturer. In no event shall the manufacturer incur liability for any consequential or unforeseeable losses.
2. This equipment guarantee shall be void if the equipment is not serviced by Prism Medical UK or its authorised service engineers, in accordance with the manufacturer's recommendations, or if any unauthorised persons carry out work on the equipment.
3. This guarantee does not apply to failure attributable to normal wear and tear, damage by natural forces, user neglect or misuse or deliberate destruction.
4. Do not attempt to service the product yourself, or the warranty is void.

14 Service Record History

Complete this section after each service, repair inspection and/or maintenance.

Date:	Time:
Service Type: Service Inspection <input type="checkbox"/> Repair <input type="checkbox"/> Other <input type="checkbox"/>	
Completed By: (Printed name) (Signature)	
Company:	
Remarks & Actions Taken:	
Product Left in A Safe & Usable Condition: Yes <input type="checkbox"/> No <input type="checkbox"/> (if no explain in actions above)	
Date:	Time:
Service Type: Service Inspection <input type="checkbox"/> Repair <input type="checkbox"/> Other <input type="checkbox"/>	
Completed By: (Printed name) (Signature)	
Company:	
Remarks & Actions Taken:	
Product Left in A Safe & Usable Condition: Yes <input type="checkbox"/> No <input type="checkbox"/> (if no explain in actions above)	
Date:	Time:
Service Type: Service Inspection <input type="checkbox"/> Repair <input type="checkbox"/> Other <input type="checkbox"/>	
Completed By: (Printed name) (Signature)	
Company:	
Remarks & Actions Taken:	
Product Left in A Safe & Usable Condition: Yes <input type="checkbox"/> No <input type="checkbox"/> (if no explain in actions above)	
Date:	Time:
Service Type: Service Inspection <input type="checkbox"/> Repair <input type="checkbox"/> Other <input type="checkbox"/>	
Completed By: (Printed name) (Signature)	
Company:	
Remarks & Actions Taken:	
Product Left in A Safe & Usable Condition: Yes <input type="checkbox"/> No <input type="checkbox"/> (if no explain in actions above)	
Date:	Time:
Service Type: Service Inspection <input type="checkbox"/> Repair <input type="checkbox"/> Other <input type="checkbox"/>	
Completed By: (Printed name) (Signature)	
Company:	
Remarks & Actions Taken:	
Product Left in A Safe & Usable Condition: Yes <input type="checkbox"/> No <input type="checkbox"/> (if no explain in actions above)	

Date:	Time:
Service Type: Service Inspection <input type="checkbox"/> Repair <input type="checkbox"/> Other <input type="checkbox"/>	
Completed By: (Printed name) (Signature)	
Company:	
Remarks & Actions Taken:	
Product Left in A Safe & Usable Condition: Yes <input type="checkbox"/> No <input type="checkbox"/> (if no explain in actions above)	
Date:	Time:
Service Type: Service Inspection <input type="checkbox"/> Repair <input type="checkbox"/> Other <input type="checkbox"/>	
Completed By: (Printed name) (Signature)	
Company:	
Remarks & Actions Taken:	
Product Left in A Safe & Usable Condition: Yes <input type="checkbox"/> No <input type="checkbox"/> (if no explain in actions above)	
Date:	Time:
Service Type: Service Inspection <input type="checkbox"/> Repair <input type="checkbox"/> Other <input type="checkbox"/>	
Completed By: (Printed name) (Signature)	
Company:	
Remarks & Actions Taken:	
Product Left in A Safe & Usable Condition: Yes <input type="checkbox"/> No <input type="checkbox"/> (if no explain in actions above)	
Date:	Time:
Service Type: Service Inspection <input type="checkbox"/> Repair <input type="checkbox"/> Other <input type="checkbox"/>	
Completed By: (Printed name) (Signature)	
Company:	
Remarks & Actions Taken:	
Product Left in A Safe & Usable Condition: Yes <input type="checkbox"/> No <input type="checkbox"/> (if no explain in actions above)	
Date:	Time:
Service Type: Service Inspection <input type="checkbox"/> Repair <input type="checkbox"/> Other <input type="checkbox"/>	
Completed By: (Printed name) (Signature)	
Company:	
Remarks & Actions Taken:	
Product Left in A Safe & Usable Condition: Yes <input type="checkbox"/> No <input type="checkbox"/> (if no explain in actions above)	

Date:	Time:
Service Type: Service Inspection <input type="checkbox"/> Repair <input type="checkbox"/> Other <input type="checkbox"/>	
Completed By: (Printed name) (Signature)	
Company:	
Remarks & Actions Taken:	
Product Left in A Safe & Usable Condition: Yes <input type="checkbox"/> No <input type="checkbox"/> (if no explain in actions above)	
Date:	Time:
Service Type: Service Inspection <input type="checkbox"/> Repair <input type="checkbox"/> Other <input type="checkbox"/>	
Completed By: (Printed name) (Signature)	
Company:	
Remarks & Actions Taken:	
Product Left in A Safe & Usable Condition: Yes <input type="checkbox"/> No <input type="checkbox"/> (if no explain in actions above)	
Date:	Time:
Service Type: Service Inspection <input type="checkbox"/> Repair <input type="checkbox"/> Other <input type="checkbox"/>	
Completed By: (Printed name) (Signature)	
Company:	
Remarks & Actions Taken:	
Product Left in A Safe & Usable Condition: Yes <input type="checkbox"/> No <input type="checkbox"/> (if no explain in actions above)	
Date:	Time:
Service Type: Service Inspection <input type="checkbox"/> Repair <input type="checkbox"/> Other <input type="checkbox"/>	
Completed By: (Printed name) (Signature)	
Company:	
Remarks & Actions Taken:	
Product Left in A Safe & Usable Condition: Yes <input type="checkbox"/> No <input type="checkbox"/> (if no explain in actions above)	
Date:	Time:
Service Type: Service Inspection <input type="checkbox"/> Repair <input type="checkbox"/> Other <input type="checkbox"/>	
Completed By: (Printed name) (Signature)	
Company:	
Remarks & Actions Taken:	
Product Left in A Safe & Usable Condition: Yes <input type="checkbox"/> No <input type="checkbox"/> (if no explain in actions above)	

Date:	Time:
Service Type: Service Inspection <input type="checkbox"/> Repair <input type="checkbox"/> Other <input type="checkbox"/>	
Completed By: (Printed name) (Signature)	
Company:	
Remarks & Actions Taken:	
Product Left in A Safe & Usable Condition: Yes <input type="checkbox"/> No <input type="checkbox"/> (if no explain in actions above)	
Date:	Time:
Service Type: Service Inspection <input type="checkbox"/> Repair <input type="checkbox"/> Other <input type="checkbox"/>	
Completed By: (Printed name) (Signature)	
Company:	
Remarks & Actions Taken:	
Product Left in A Safe & Usable Condition: Yes <input type="checkbox"/> No <input type="checkbox"/> (if no explain in actions above)	
Date:	Time:
Service Type: Service Inspection <input type="checkbox"/> Repair <input type="checkbox"/> Other <input type="checkbox"/>	
Completed By: (Printed name) (Signature)	
Company:	
Remarks & Actions Taken:	
Product Left in A Safe & Usable Condition: Yes <input type="checkbox"/> No <input type="checkbox"/> (if no explain in actions above)	
Date:	Time:
Service Type: Service Inspection <input type="checkbox"/> Repair <input type="checkbox"/> Other <input type="checkbox"/>	
Completed By: (Printed name) (Signature)	
Company:	
Remarks & Actions Taken:	
Product Left in A Safe & Usable Condition: Yes <input type="checkbox"/> No <input type="checkbox"/> (if no explain in actions above)	
Date:	Time:
Service Type: Service Inspection <input type="checkbox"/> Repair <input type="checkbox"/> Other <input type="checkbox"/>	
Completed By: (Printed name) (Signature)	
Company:	
Remarks & Actions Taken:	
Product Left in A Safe & Usable Condition: Yes <input type="checkbox"/> No <input type="checkbox"/> (if no explain in actions above)	

Date:	Time:
Service Type: Service Inspection <input type="checkbox"/> Repair <input type="checkbox"/> Other <input type="checkbox"/>	
Completed By: (Printed name) (Signature)	
Company:	
Remarks & Actions Taken:	
Product Left in A Safe & Usable Condition: Yes <input type="checkbox"/> No <input type="checkbox"/> (if no explain in actions above)	
Date:	Time:
Service Type: Service Inspection <input type="checkbox"/> Repair <input type="checkbox"/> Other <input type="checkbox"/>	
Completed By: (Printed name) (Signature)	
Company:	
Remarks & Actions Taken:	
Product Left in A Safe & Usable Condition: Yes <input type="checkbox"/> No <input type="checkbox"/> (if no explain in actions above)	
Date:	Time:
Service Type: Service Inspection <input type="checkbox"/> Repair <input type="checkbox"/> Other <input type="checkbox"/>	
Completed By: (Printed name) (Signature)	
Company:	
Remarks & Actions Taken:	
Product Left in A Safe & Usable Condition: Yes <input type="checkbox"/> No <input type="checkbox"/> (if no explain in actions above)	
Date:	Time:
Service Type: Service Inspection <input type="checkbox"/> Repair <input type="checkbox"/> Other <input type="checkbox"/>	
Completed By: (Printed name) (Signature)	
Company:	
Remarks & Actions Taken:	
Product Left in A Safe & Usable Condition: Yes <input type="checkbox"/> No <input type="checkbox"/> (if no explain in actions above)	
Date:	Time:
Service Type: Service Inspection <input type="checkbox"/> Repair <input type="checkbox"/> Other <input type="checkbox"/>	
Completed By: (Printed name) (Signature)	
Company:	
Remarks & Actions Taken:	
Product Left in A Safe & Usable Condition: Yes <input type="checkbox"/> No <input type="checkbox"/> (if no explain in actions above)	

User notes:

Dealer/service contact details:

Manufacturer contact details:

Prism Medical UK

Unit 1, Tir Llwyd Industrial Estate,
St Asaph Avenue, Kinmel Bay,
Conwy, United Kingdom, LL18 5JZ

Telephone Number: 01924 840100

Disclaimer

While every effort has been made to ensure the accuracy of information contained in this user manual, no liability can be accepted by Prism Medical UK for any errors or omissions. Prism Medical UK operates a policy of continuous improvement. Specifications and other data are subject to change without notice.

www.prismmedical.co.uk

